

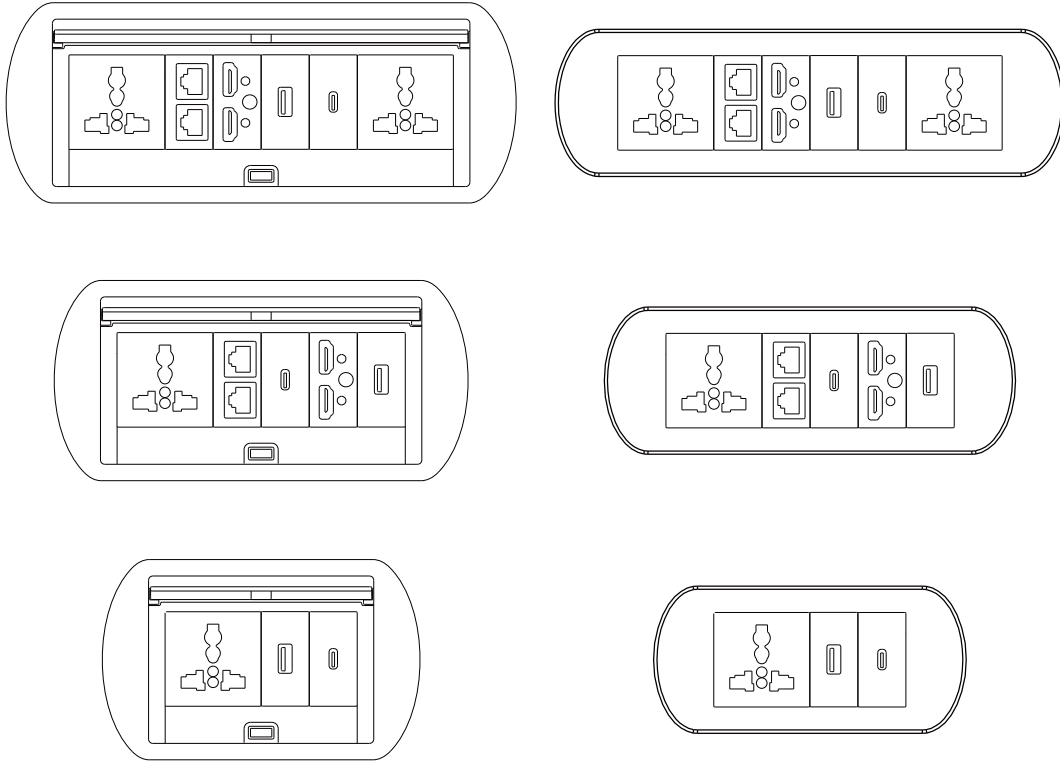

# M-Desktop Socket



## Keywords

- *Modular design to facilitate flexible set-up*
- *Friendly to installer and user, no tools required*
- *Compatible with diverse power standard worldwide*
- *Inclined inner frame to avoid power cord interference*



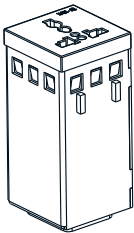
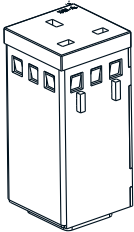
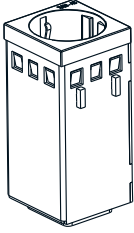
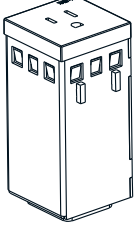
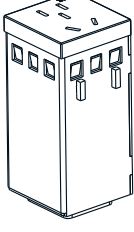
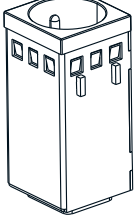

## Available Modules

 Modules color: RAL9005

Model	Description	Specs	Figure
DM-UN	Universal standard power socket	Input 100-250V ~50/60Hz 10A Fuse - 10A 250V OUT-Maximum 5A	
DM-GB	United kingdom power socket	Input 100-250V ~50/60Hz 10A Fuse - 10A 250V OUT-Maximum 5A	
DM-DE	Germany(Western Europe)power socket	Input 100-250V ~50/60Hz 10A Fuse - 10A 250V OUT-Maximum 5A	
DM-US	American power socket	Input 100-250V ~50/60Hz 10A Fuse - 10A 250V OUT-Maximum 5A	
DM-CH	Chinese standard power socket	Input 100-250V ~50/60Hz 10A Fuse - 10A 250V OUT-Maximum 5A	
DM-FR	French standard socket	Input 100-250V ~50/60Hz 10A Fuse - 10A 250V OUT-Maximum 5A	

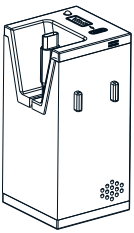
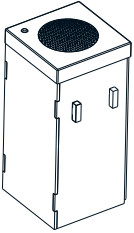
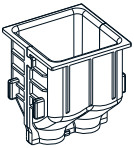
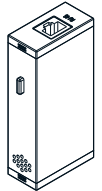
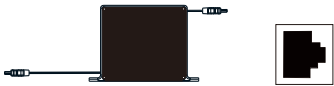
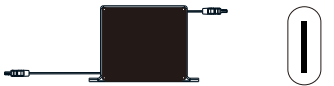



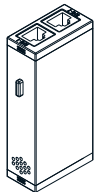
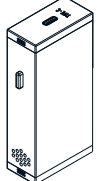
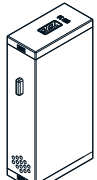
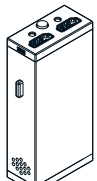
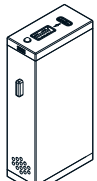

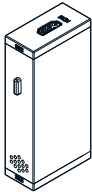
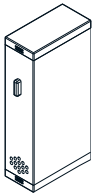
Model	Description	Specs	Figure
KM-CC	Fast charging module+extendable cable	Input 100-250V ~50/60Hz 10A Output TYPE-C: 5V3A/9V3A/12V3A/15V3A/20V3.25A (65W) USB-A :5V3A/9V2A/12V1.5A <i>Scalablecable:</i> 5V3A/9V3A/12V3A/15V3A/20V3.25A (65W) Cable length:70mm	
KM-BL	<i>Supports Bluetooth connection and playback for devices such as mobile phones and tablets</i>	Input 5V-1A	
KM-2C	Pass-through module with 2 hole.Accommodates cables up to 10 mm in diameter	2hole	
KM-1RJ45	Passive module with 1 RJ45 port input 1 female output	S/FTP CAT6a	
RET-RJ45	RJ45 retractable cable	RJ45, retractable length 1500mm, fixed end 400mm	
RET-TYPE-C	Type-C retractable cable	3in1, retractable length 1500mm, fixed end 250mm Data transfer speed: 3.2 Gen, 20Gbps max. Resolution: 4K Charging speed: 100W max.	

Model	Description	Specs	Figure
RET-USB-A	USB-A retractable cable	USB-A 3.0, retractable length 1500mm, fixed end 250mm Data transfer speed: 5Gbps max.	
RET-HDMI	HDMI retractable cable	HDMI 2.0, retractable length 1500mm, fixed end 250mm Resolution: 4K@60Hz, 120Hz	
KM-2RJ45	Passive module with 2 Rj45 ports input 2 female outputs	S/FTP CAT6a	
KM-TC	Passive module with 1 USBC FF port input female .Output - 1USBC female	Full feature - 4K 10Gbps ,65w power charging	
KM-UB	Passive module with 1 USBA FF port input female .Output - 1USBA female	5Gbps.	
KM-2H/1	Passive module with 2 HDMI port input female .Output - 1HDMI female.And it has a switching function.	4K-60Hz	
KM-AC	1 USB-A + 1TYPE-C	Input 100-250V ~50/60Hz 10A Output TYPE-C: 5V3A/9V3A/12V3A/15V3A/20V3. 25A (65W) USB-A :5V3A9V/2A 12V1. 5A	

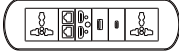
Model	Description	Specs	Figure
KM-1H	Passive module with 1 HDMI port input female .Output - 1HDMI female	4K-60Hz	
KM-KB	<i>Fill in the vacant installation position</i>		

## Table Cutout Dimensions

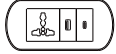
Model	Product images	Table opening size
M4		203*84mm(7.99" X 3.31")
		200*57mm(7.87" X 2.24")
M3		158*84mm(6.22" X 3.31")
		155*57mm(6.1" X 2.24")
M2		113*84mm(4.45" X 3.31")
		110*57mm(4.33" X 2.24")

 We recommend using the template (packed with device) for maximal accuracy

 Table thickness: 20-80mm (0.787-3.15")

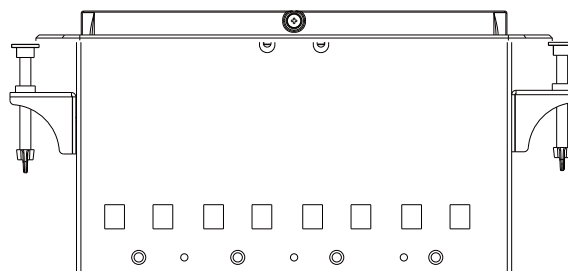
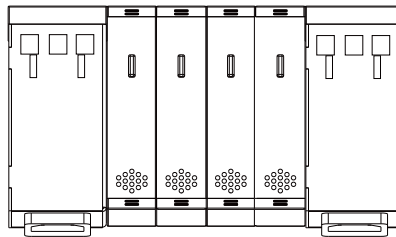
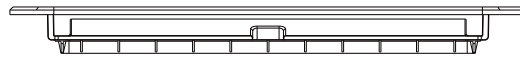

# Installation Guidance

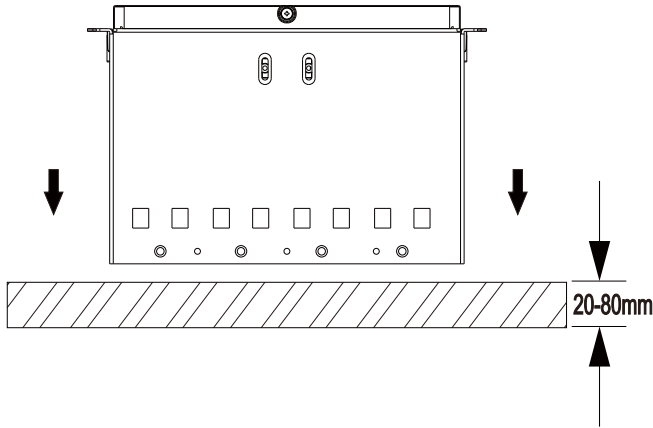

1.Product installation enters the desktop

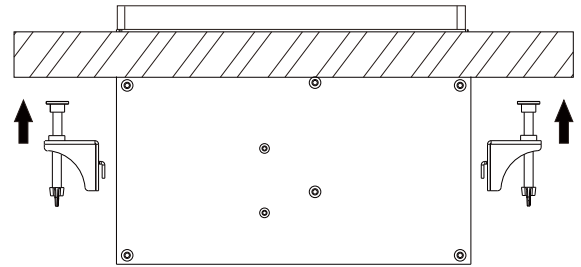

2.The product is fixed in the table

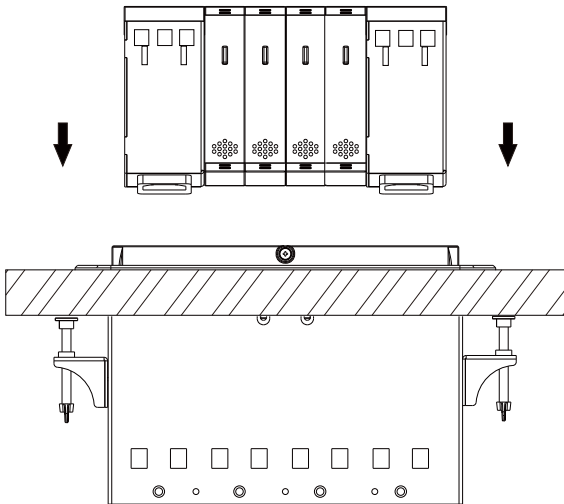

3.Module installation into product

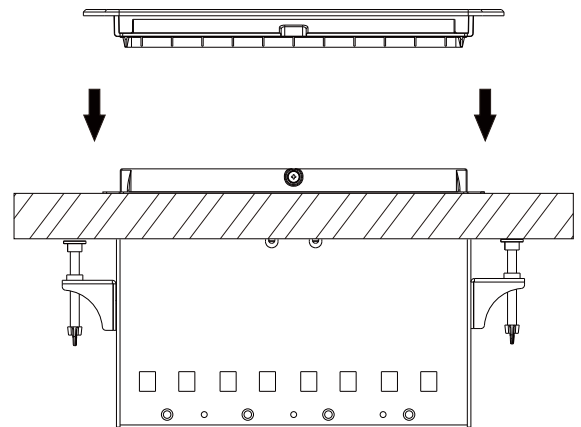

4.Install the frame and decorative panel

# Installation Guidance

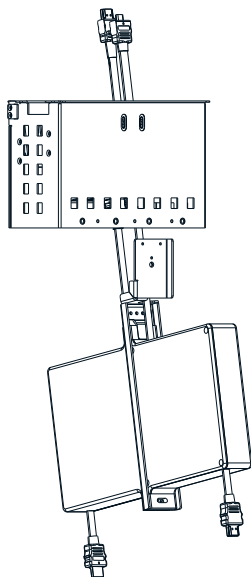

5. Pull out the cable from under the desk to the desktop

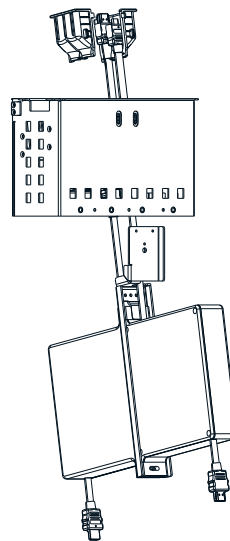

6. Put the cables into and out of the cable box

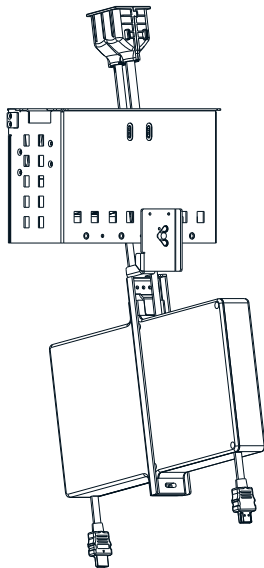

7. Merge the outlet box and install it into the socket box

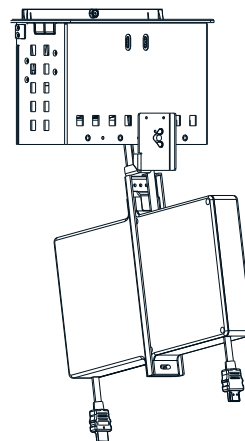

8. Install the decorative frame properly  
Tighten the butterfly screw